

Melbourne's Climate

Building design for a sustainable future



Included in this fact sheet:

Climate responsive design:

- The changing angle of the sun
- Melbourne sun path
- Temperatures
- Thermal mass and night purging
- Rainfall
- Wind

Our changing climate

Where can I find out more?

Mandatory Requirements

Council's Design Advice

This fact sheet examines Melbourne's climate and the impact it has on the design and construction of residential and commercial buildings.

Melbourne's climate significantly changes with the seasons and often is referred to as having four seasons in one day. But how do you design buildings for a climate such as this?

Designing for the local environment means acknowledging Melbourne's climatic patterns including the changing angles of the sun, temperature variations, rainfall patterns and prevailing winds. It means orientating your building correctly, applying different types of external sun shading, locating heavy weight materials or 'thermal mass' where it can trap winter warmth and selecting rainwater tanks of the appropriate size to optimise rainwater collection and use - even in the drier months.

Best practice building design should not only account for these climate variations, but use them to its advantage. Just as your wardrobe responds to different seasons so should the buildings we inhabit.

Climate responsive design

A totally climate responsive building is one which requires no active heating or cooling but remains comfortable all year round. There are many benefits to climate responsive design:

- Indoor Environment Quality – Living or working in a building that stays cool in summer, warm in winter and provides good levels of daylight and natural ventilation throughout the year is what every occupant desires. Good building design achieves this by responding to its local climate.
- Energy cost savings – 34% of an average home's energy use is in heating and cooling. A further 11% is used for lighting. So designing buildings that naturally provide comfortable temperatures and plenty of natural light can really pay off.

- Investment in the future – Developers and residents are increasingly starting to recognise the benefits of lower ongoing costs and the health and comfort a well designed building can provide. All of these attributes are increasingly factored into their up-front decision making.
- Environmental Impact – Climate responsive building design is not only good for its occupants but also for the environment. Through the reduced need for energy hungry services we can minimise our reliance on non-renewable resources and therefore reduce our overall greenhouse gas emissions.



Melbourne's Sun Angels and Sun Path



Melbourne's sun angles

Understanding a location's changing sun angle (altitude) and direction (azimuth) throughout the year and day are probably the two most vital aspects when designing energy efficient buildings with high indoor environment qualities.

The tables below explain these changes and should always be considered when designing a building's floor plan, windows and sun shading.

During summer, northern sun angles reach their highest point at 75.5°. Eastern and western sun angles are relatively lower throughout the year.

Eastern facades are exposed to solar heat gains just as much as western facades, only we perceive it as less as the ambient temperatures are cooler in the morning. All this is important to consider, particularly when designing sun shading for different facades.

During winter, the northern facade is the main source for passive solar heat gains. It is therefore important to design windows and shading that allow for maximum solar access into a home during this time. Non-residential buildings, however, may be better to shade throughout the year.

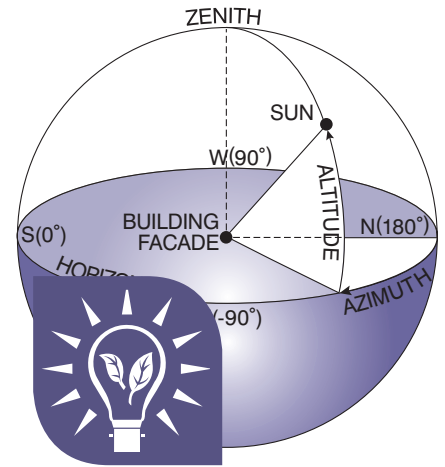

Summer 21 Dec*

Time	Altitude	Azimuth	
5:00	0	-55.2	East
6:00	0	-64.2	
7:00	10.37	-68.34	
8:00	21.71	-76.45	
9:00	33.43	-84.58	
10:00	45.32	-93.58	
11:00	57.05	-105.15	North
12:00	67.92	-123.81	
13:00	75.35	-161.92	
14:00	73.52	145.51	
15:00	64.36	116.02	West
16:00	53.05	100.68	
17:00	41.22	90.3	
18:00	29.36	81.73	
19:00	17.74	73.68	
20:00	6.59	65.43	

*Data for Daylight Saving Time is shown.

Winter 21 June

Time	Altitude	Azimuth	
5:00	0	0	East
6:00	0	0	
7:00	0	0	
8:00	3.21	-123.02	
9:00	12.58	-133.2	
10:00	20.38	-145.03	
11:00	26.01	-158.69	North
12:00	28.84	-173.87	
13:00	28.49	170.45	
14:00	24.99	155.54	
15:00	18.83	142.27	West
16:00	10.64	130.84	
17:00	0.99	120.97	
18:00	0	116.0	
19:00	0	0	
20:00	0	0	

Spring/Autumn*

Time	Altitude	Azimuth	
5:00	0	0	East
6:00	0	0	
7:00	8.44	-97.54	
8:00	20.07	-107.34	
9:00	31.04	-118.72	
10:00	40.71	-132.92	
11:00	48.07	-151.31	North
12:00	51.67	-174.01	
13:00	50.44	162.09	
14:00	44.78	141.39	
15:00	36.1	125.23	West
16:00	25.69	112.6	
17:00	14.34	102.13	
18:00	2.55	92.73	
19:00	0	89.4	
20:00	0	0	

*The table shows data for 21 Sept. Figures for the 21 March vary very slightly and must add one hour for daylight saving.

Melbourne sun path

The transparent sun path diagram in this fact sheet can be used to determine the sun's impact on a window; throughout the day and year.

The diagram's circles represent the sun's altitude. The radial lines represent the sun's azimuth. Both are drawn at 15° intervals. The small circles indicate the sun's position in the sky at one hour intervals at the summer and winter solstice and the spring and autumn equinox.

Follow these steps to assess the sun exposure of your building design:

- Align the centre of the diagram with the centre of the window to be assessed.
- Rotate the diagram until its orientation matches the one of your drawing.
- Now you see at what times of the day and year the window is exposed to the sun.
- Furthermore, the diagram demonstrates the different sun angles (altitude) for those different times and seasons.
- In the example to the left, the north-east facing window is exposed to summer sun from 9am to 2:30pm (area shaded purple in diagram).

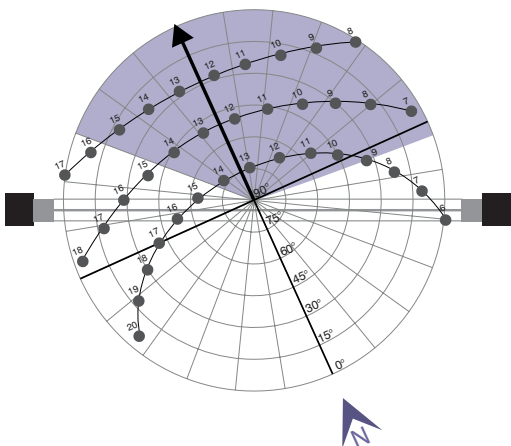



Melbourne's temperatures and rain

The chart to the right shows Melbourne's temperature distribution throughout the year.

The monthly 'Highest' temperature shows the past highest daily maximum for the month. The monthly 'Mean maximum' temperature shows the average daily maximum for the month. The monthly 'Mean minimum' temperature shows the average daily minimum for the month. The monthly 'Lowest' temperature shows the past lowest minimum for the month.

Maximum temperatures are usually measured in the afternoon; minimum temperatures just before sunrise.

The shaded area indicates typical day and night time temperatures throughout the year.

The hatched area between 'Indoor Max' and 'Indoor Min' indicates what occupants perceive as a comfortable indoor temperature, depending on the season and what clothing they wear.

When overlaying the different areas you can see that Melbourne's climate actually provides us with comfortable temperatures for most of the year. A sensibly designed building should require mechanical heating and cooling for only a short period.

When designing for Melbourne's climate, it is important to not only consider the mean temperatures but also the extreme temperatures that dramatically impact on our indoor environment quality.

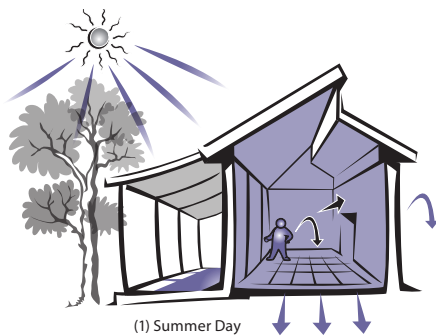
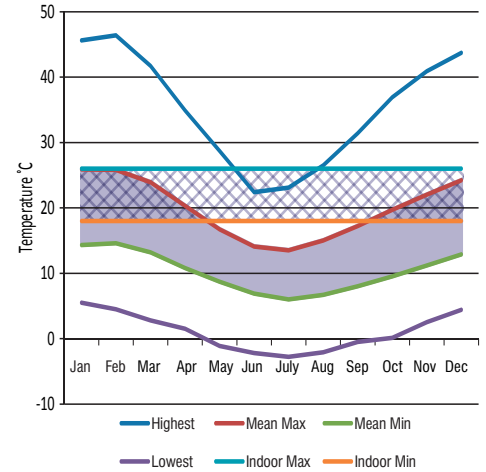

Thermal mass and night purging

(1) During a hot summer's day, building structures absorb heat build-up from solar gain, electronic equipment and user occupancy. The more thermal mass (i.e. concrete floors or brick walls) that is exposed to the interior, the more heat can be stored.

(2) But just as a sponge that is absorbing water, at some point it cannot take any more. It needs to be 'wrung out'. In the evening, when temperatures have dropped, its time to open windows so the building structure can be cooled.

This method is often referred to as 'night-purging'. Given that heat rises, high level windows, skylights and thermal chimneys work best to release excess heat from a building.

(3 & 4) By exposing thermal mass to direct solar energy in winter, it can also be used as a 'heat bank' to store warmth when internal temperatures drop.

But don't forget - thermal mass is only effective if properly insulated from the exterior of the building.

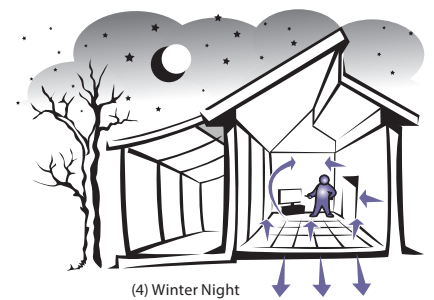
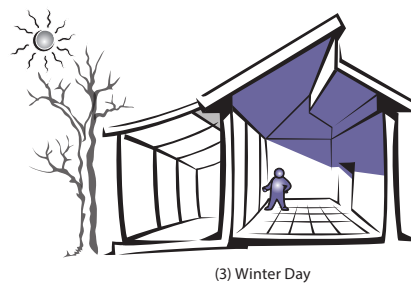
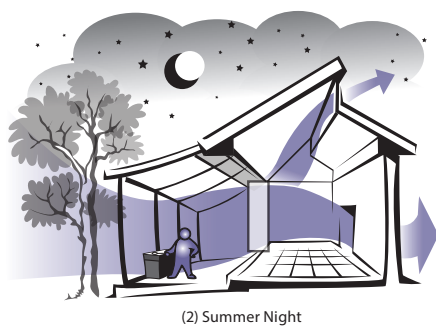

Rainfall

The chart to the right shows Melbourne's annual rainfall data for the last 150 years. It shows that on average, we experience an annual rainfall of 650mm relatively evenly spread over the year. However, this can change dramatically from year to year. During the El Niño-Southern Oscillations, the climate in south-eastern Australia is much drier and monthly rainfall can be very low. Whereas during La Niña, it is considerably wetter and we can experience extremely high rainfalls.

It should also be noted that there are significantly more rain days in winter than in summer, meaning our summer rain generally comes in bigger bursts.

These monthly and yearly variations should be considered when:

- sizing rainwater tanks to reduce demand on potable water, and
- designing site permeability to help control drainage in peak rainfall events.

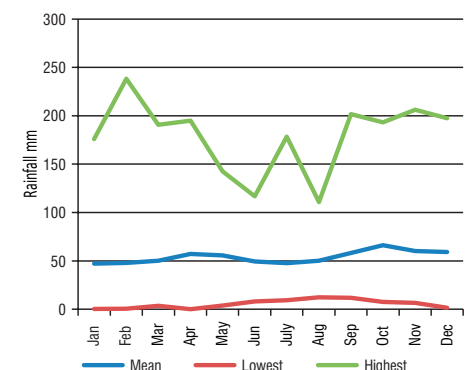

Melbourne's Wind & Adaptive Design



Melbourne's wind

Despite Melbourne's reputation for erratic weather, prevailing wind patterns can be identified for the various seasons.

Warm northerly winds prevail in winter, resulting in occasional warmer days.

Wind direction varies during summer mornings but tends to be southerly during the afternoon, providing a cool change.

Therefore the installation of openable high level windows in southern facades provide

the best opportunity for passive cooling. The wind roses below indicate Melbourne's morning and afternoon wind direction and intensity during summer and winter

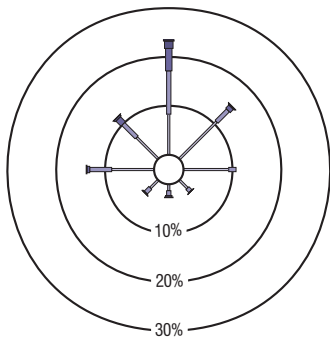

9am Winter

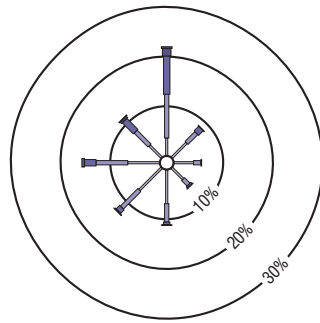

3pm Winter

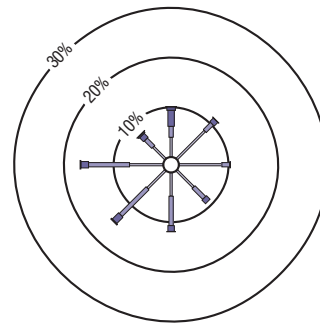

9am Summer

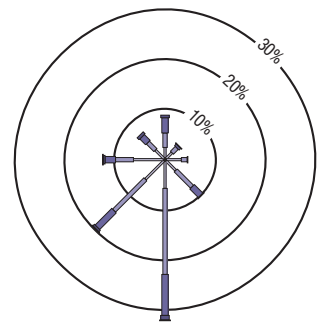

3pm Summer

Climate adaptive design

The impact of climate change will directly affect the performance of our existing buildings. Given the lifetime of a building is generally 50 years or more, this has a significant impact on the way we design now. Localised direct impacts are likely to include:

- Increased land and sea temperatures (Australia has already experienced an increase of 0.9° since 1950)
- Further sea level rises (20mm per decade over last 5 decades)
- An increased number of extreme weather events (more heatwaves, bushfires, peak rainfall and storm events)

- A reduction in annual rainfall across south-eastern Australia

Buildings which are designed sensibly for the local climate respond much better to temperature extremes. It has become vital to respond to higher expected temperatures through external shading, natural ventilation, thermal mass, thermal insulation and landscaping for seasonal heat control.

Buildings which consider permeability and incorporate water reuse will prove more adaptable to flooding and respond better to future constraints on potable water.

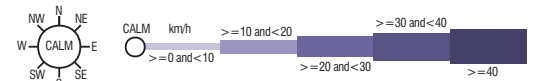

Mandatory Requirements and Council's Design Advice

Mandatory Requirements
Your building design in Melbourne must consider NCC requirements for the relevant climate zone depending on location.

Council's Design Advice
A building design that not only accommodates but utilises Melbourne's diverse climate.

Consider showing on Planning Permit Application Drawings:

- External shading provisions, including landscaping
- Schematic sections that demonstrate efficient shading
- Schematic sections that demonstrate natural ventilation strategy
- Location of significant internal mass
- Site permeability and stormwater treatment and detention systems

Where can I find out more?

Historic climate data and statistics
Bureau of Meteorology
www.bom.gov.au

Sun Movement App - SunCalc
www.suncalc.net

Passive design advice
Your Home
www.yourhome.gov.au

Understanding climate change
State Government Victoria
www.climatechange.vic.gov.au

For further information on our climate and sustainable building design, consider the other Fact Sheets in this series entitled:

- Indoor Environment Quality
- Energy Efficiency
- Stormwater Management
- Urban Ecology
- Innovation
- Permeability
- Sun Shading
- Green Roofs, Walls and Facades

Melbourne Sun Path

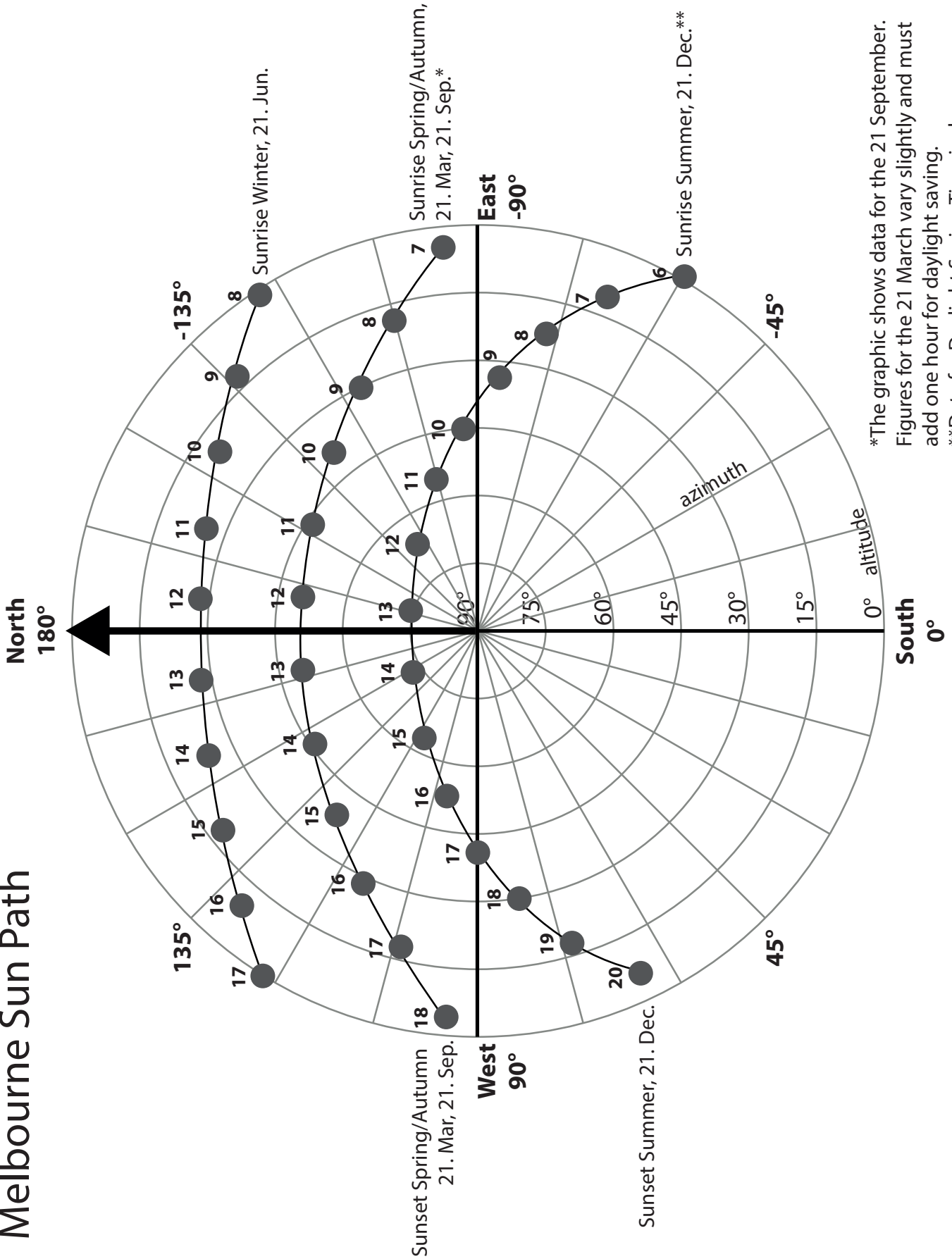

*The graphic shows data for the 21 September. Figures for the 21 March vary slightly and must add one hour for daylight saving.
**Data for Daylight Saving Time is shown.